





PLASTIC AUTOMATIC CABLE REELS WITH ELECTRIC CABLE AND SWIVELLING BRACKET AND PORTABLE LAMP

Article	Cable lenght	Cable type	Inlet voltage	Outlet voltage	Led light	Light power
078-3435-215	15 m	2GX1 mm ² H05RN-F	12V / 24V~AC	12V / 24V~AC	18 Led	900 lumen

Automatic cable reel without transformer Mod. ES-260L I 15 m

- Automatic spring rewinding
- Plastic outer casing
- Steel swivelling wall bracket
- User can stop the cable at the required lenght
- **With portable lamp 18 Led**
- CE approved
- TÜV approved

			
078-3435-215	3,900	0,028	1

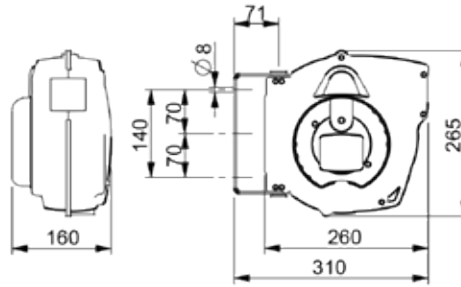





ES-260L

Article	Cable lenght	Cable type	Inlet voltage	Outlet voltage	Led light	Light power
078-3440-215	15 m	2GX1 mm ² H05RN-F	230V	da 12V a 24V	18 Led	900 lumen

Automatic cable reel with transformer Mod. ES-260L I 15 m

- Automatic spring rewinding
- Plastic outer casing
- Steel swivelling wall bracket
- User can stop the cable at the required lenght
- **With portable lamp 18 Led**
- CE approved
- TÜV approved

			
078-3440-215	4,400	0,028	1

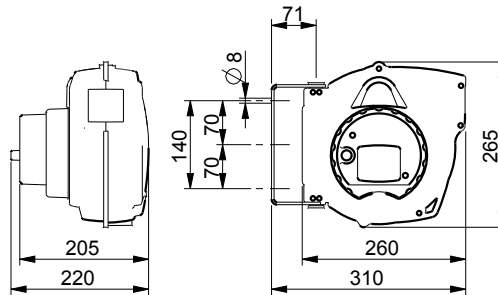





ES-260L

Article	Operating voltage	N° LED	Light power	Protection rating
078-3448-018	12V / 24V~AC	18	900 lumen	IP65

Led portable lamp

- Transparent protective cover
- Non-slip handle with switch
- Adjustable hook
- **With lamp 18 Led**
- Usage voltage 12 - 24V

			
078-3448-018	0,350	0,002	1

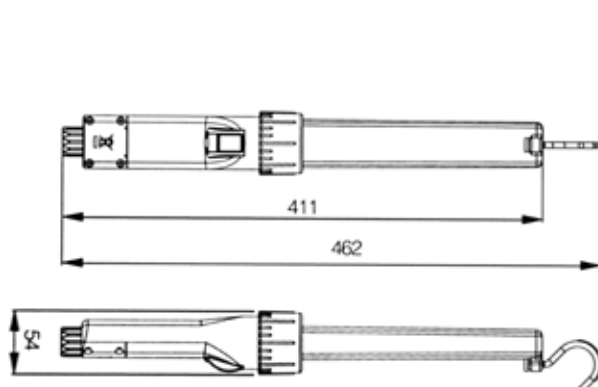

ES-260L