

SWIVELLING AUTOMATIC HOSE REELS IN PAINTED STEEL FOR AIR-WATER 20 bar

Equipped with:

- Blue polyurethane ether-based hoses
- Nickel-plated brass or galvanized steel connections
- Brass 90° swivelling joint
- Viton® seals

Article	L. hose	Ø hose	Max pressure	Inlet-Outlet
071-1201-300	without hose	-	-	F1/2"G - M3/8"G
071-1201-400	without hose	-	-	F1/2"G - M1/2"G
071-1201-215	15 m	8x12	20 bar	F1/2"G - M1/4"G gir.
071-1201-220	20 m	8x12	20 bar	F1/2"G - M1/4"G gir.
071-1201-310	10 m	10x14	20 bar	F1/2"G - M3/8"G
071-1201-315	15 m	10x14	20 bar	F1/2"G - M3/8"G
071-1201-410	10 m	13x19	20 bar	F1/2"G - M1/2"G

S-400



Article	L. hose	Ø hose	Max pressure	Inlet-Outlet
071-1301-300	without hose	-	-	F1/2"G - M3/8"G
071-1301-400	without hose	-	-	F1/2"G - M1/2"G
071-1301-320	20 m	10x14	20 bar	F1/2"G - M3/8"G
071-1301-415	15 m	13x19	20 bar	F1/2"G - M1/2"G
071-1301-418	18 m	13x19	20 bar	F1/2"G - M1/2"G

S-460





Article	L. hose	Ø hose	Max pressure	Inlet-Outlet
071-1401-400	without hose	-	-	F1/2"G - M1/2"G
071-1401-420	20 m	13x19	20 bar	F1/2"G - M1/2"G
071-1401-425	25 m	13x19	20 bar	F1/2"G - M1/2"G

S-550



OVERALL DIMENSIONS SWIVELLING VERSION

Mod.	A	B	C	D	E	F	G	H			
S-400	150	120	168	196	95	460	400	550	15,51<17,51	0,084	1
S-460	150	120	168	196	95	490	460	575	17,50<24,00	0,094	1
S-550	200	150	225	270	120	572	550	680	23,00<29,00	0,130	1

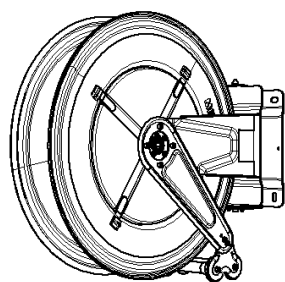
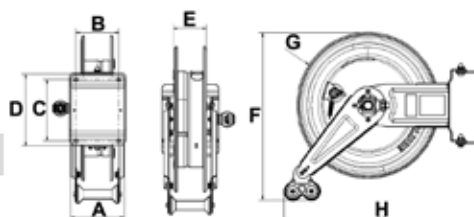

Wall application with internal output hose

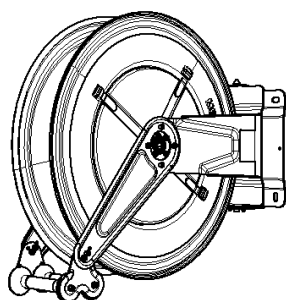

Wall application with external output hose

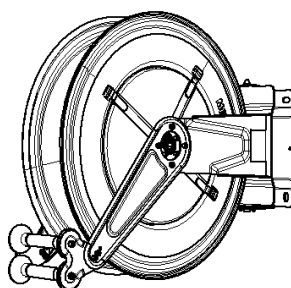

Wall and ceiling application with frontal outside hose

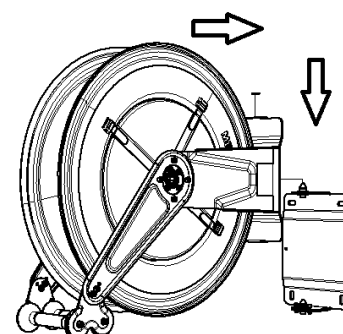

The insertion of the hose reel in the wall bracket is with quick disconnect coupling